

Proposal Number: #53-25-011

Vendor: _____

ATTACHMENT H: SCOPE OF WORK – EXHIBIT 5 AIR COMPRESSOR/GENERATOR AS PER MODEL “MILLER A60GB” AS SHOWN W/OPTIONAL AIR DRYER #301488

EnPak® A60 Series

Diesel Engine-Driven
Air Compressor/Generator/
Battery Charger/Crank Assist/
Hydraulic Pump/Welder



Quick Specs

Processes

(A60GBW and A60GBHW models only)

- DC stick (SMAW)
- MIG (GMAW)*
- Aluminum MIG (GMAW)*
- Flux-cored (FCAW)*
- DC TIG (GTAW)
- Air carbon arc (CAC-A)
- 1/4-inch (6.35 mm) carbons

*With wire feeder.

Air Compressor

- 58 cfm at 100 psi,
- 60 cfm max.,
- 100% duty cycle

Generator Power

- 7,000 watts continuous

Battery Charge

- 12/24 V, 150 A

Crank Assist 12/24 V, 300 A

Hydraulic Pump

(A60GBH and A60GBHW models only)

- 8 gpm at 3,000 psi, 16 gpm max. flow

Output Range

(A60GBW and A60GBHW models only)

- DC stick 30–325 A
- DC TIG 20–325 A
- MIG/flux-cored 15–40 V

The EnPak A60 includes more capabilities in a small footprint, with 325 amps of integrated multiprocess welding output, battery charge/crank assist and more. This all-in-one is designed with industry-leading technologies to help you get more work done, reduce engine hours on your truck and maximize the return on your investment.



User interface panel



Battery charge/crank assist panel



Weld output panel
A60GBW and A60GBHW models only



Auxiliary power remote panel
Installation option on all models



Welder/generator/air compressor/hydraulic pump/battery charger is warranted for three years, parts and labor.
Engine is warranted separately by the engine manufacturer.



Miller Electric Mfg. LLC
An ITW Welding Company
1635 West Spencer Street
P.O. Box 1079
Appleton, WI 54912-1079 USA

Equipment Sales US and Canada
Phone: 866-931-9730
FAX: 800-637-2315
International Phone: 920-735-4554
International FAX: 920-735-4125

MillerWelds.com
f X y o i n



EnPak® A60 Series Models



The EnPak A60 is available in four configurations:

EnPak A60GB*

- Air compressor
- Generator power
- Battery charge/crank assist
- Chassis power

Comes standard with user interface panel and battery charge/crank assist panel.

EnPak A60GBH*

- Air compressor
- Generator power
- Battery charge/crank assist
- Chassis power
- Hydraulic pump

Comes standard with user interface panel and battery charge/crank assist panel.

EnPak A60GBW*

- Air compressor
- Generator power
- Battery charge/crank assist
- Chassis power
- Integrated multiprocess welding

Comes standard with user interface panel and battery charge/crank assist panel and weld output panel.

EnPak A60GBHW*

- Air compressor
- Generator power
- Battery charge/crank assist
- Chassis power
- Hydraulic pump
- Integrated multiprocess welding

Comes standard with user interface panel and battery charge/crank assist panel and weld output panel.

**Available as a Cold Weather Package which adds factory-installed diesel fuel heater and compressor oil heater. See page 8. Engine block heater standard on all models.*

User interface panel

Includes 30 feet (9 m) of cabling.



Battery charge/crank assist panel

Cabling is provided by integrator.



Weld output panel

A60GBW and A60GBHW models only. Cabling is provided by integrator.



Auxiliary power remote panel

Installation option on all models — see page 8. Cabling is provided by integrator.



EnPak® A60 Series Features



Air compressor

The EnPak A60 features a 60 cfm rotary-screw compressor that can power virtually any air tool, including most one-inch impact wrenches. The rotary-screw compressor reliably provides air on demand.



Generator power

The EnPak A60 provides a 7,000-watt generator that can handle most jobsite electrical needs — electrical tools, lights, and more.

The optional auxiliary power panel provides two 120-volt GFCI-protected duplex receptacles and one 120/240-volt receptacle with 60 Hz current.



Battery charge/crank assist

The EnPak A60 produces up to 150 amps of DC current to quickly charge 12- and 24-volt batteries. It can provide jobsite equipment with weak batteries up to 300 amps of crank assist.



Chassis power

Integrated into the truck, chassis power monitors the battery and automatically charges it as needed. Technicians can turn off their truck without worrying about jobsite tools draining the battery — leaving them stranded.



Hydraulic pump

The Casappa® variable-displacement pump supports reliable, precise crane operation (A60GBH and A60GBHW models only), delivering 16 gpm, open center.

Note: Closed center conversion kit available as an option. See page 8.



Integrated multiprocess welding

The EnPak A60 provides multiprocess weld capabilities including carbon arc gouging (A60GBW and A60GBHW models only) with 325 amps of output (100 percent duty cycle) so technicians are prepared for each welding job they encounter in the field.



Remote panels

The EnPak A60 has a new innovative LCD user interface panel that improves the user experience, provides full visibility to the system and empowers technicians to manage their power needs. The EnPak A60 also includes a battery charge/crank assist panel, weld output panel and an optional auxiliary power panel.



Turbocharged engine

The EnPak A60 utilizes a turbocharged diesel engine, delivering more power at lower speeds (2,800 rpm). It outperforms in every environment — even at high elevations — so operators have the power they need to work anywhere.



Auto-Speed™ technology

Advanced Auto-Speed technology automatically varies engine speed from 1,800–2,800 rpm to match compressed air, battery charge and weld demands — reducing fuel consumption, maintenance costs and noise for more efficient jobsites.



Auto start/stop

Auto start/stop automatically turns the EnPak engine on and off based on demand, reducing fuel consumption and noise — which improves the work environment.



CAN bus connectivity

Allows the EnPak A60 to connect to a telematics system so you can monitor engine data, machine loads and usage. Track service intervals, schedule maintenance proactively and improve diagnostics of your EnPak power system.

Function and Benefit Guide



User interface panel

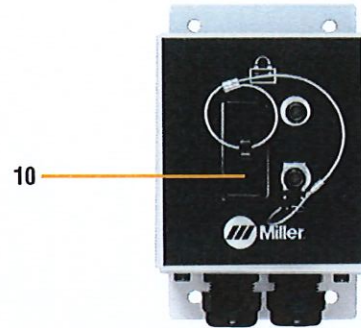

Battery charge/crank assist panel

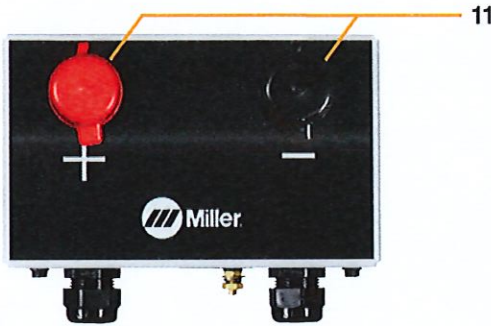

Weld output panel (A60GBW and A60GBHW models only)

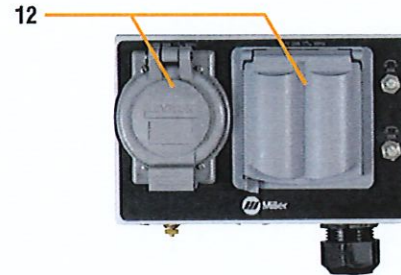

Optional auxiliary power remote panel

1. **LCD screen/visual dashboard.** Shows key performance indicators of all EnPak A60 systems and lets operator change settings and configurations easily and quickly.
2. **Welding menu button (A60GBW and A60GBHW models only)** enables weld mode. Once in weld mode, select weld process and weld settings.
3. **Battery charge button.** Once in battery charge mode, select either 12V or 24V charge or crank assist.
4. **Air compressor button.** Turns the air compressor on/off. Air use determines engine speed.
5. **Settings button.** Use to access settings, maintenance and system information menus.
6. **Information LED** notifies operator when EnPak is ready to start and is used to provide status when doing software updates.
7. **Engine control button** is used to start and stop the engine.
8. **Pushbutton main control knob** used for adjusting amperage/voltage, adjusting arc control, and accessing the service menu.
9. **USB port** allows software updates from a USB drive. A summary file of recorded data from the unit will be saved to a USB drive that is inserted.
10. **Battery charge/crank assist receptacle** for Anderson-style connection to battery charge/crank assist (12 or 24 volt).
11. **Weld output receptacles (Tweco®-style).**
12. **Optional 120 V receptacles w/circuit breakers and 120/240 V, 50 A receptacle**
Note: For matching 50 A plug, order 119172.

Air Compressor Specifications

Air Compressor Brand and Warranty	Features	Free Air Delivery	Working Pressure	Duty Cycle	Oil Capacity	Automatic Compressor Shutdowns
Rotorcomp, covered under the Miller® 3-year warranty	Rotary screw with electric clutch for on/off. Oil change intervals of 500 hours.	60 cfm (1.70 m³/min.)	80–175 psig	100%	3 qt. (2.8 L)	High pressure (200 psi), high temperature

Hydraulic Pump Specifications

Hydraulic Pump Brand and Warranty*	Pump Type	Rated Output	Maximum Pressure	Maximum Flow Rate
Casappa, covered under the Miller® 3-year warranty	Variable displacement piston	8.0 gpm at 3,000 psi at 2,800 rpm, 50% duty cycle	3,500 psi	16 gpm (open center) 16 gpm (with optional closed center conversion kit)

*A60GBH and A60GBHW models only.

Battery and Weld Specifications

Process	Output Ranges	Rated Output at 104°F (40°C)**	Single-Phase Generator Power	Sound Levels at 7 m (23 ft.)	Dimensions	Net Weight***
Chassis power	12 V	150 A	Continuous: 7,000 watts	Idle: 65.6 dB High speed: 69 dB (rated load)	Machine H: 27 in. (686 mm) W: 21 in. (533 mm) D: 46 in. (1,168 mm) Main Control Panel H: 8.9 in. (226 mm) W: 10.3 in. (255 mm) D: 2.5 in. (63.5 mm)	A60GB 641 lb. (291 kg)
Battery charge/crank assist	12/24 V	Charge: 150 A, Crank assist: 300 A				A60GBH 737 lb. (334 kg)
DC stick*	30–325 A	325 A at 30 V, 100% duty cycle				A60GBW 646 lb. (293 kg)
DC TIG*	20–325 A					A60GBHW 740 lb. (336 kg)
MIG/FCAW*	15–40 V					

*A60GBW and A60GBHW models only. **Rated at sea level. ***Net weight without fuel, with standard remote panels.

Engine Specifications (Engines warrantied separately by the engine manufacturer.)

EnPak A60 Model	Engine Brand and Warranty	Horsepower (HP)	Type	Power Speed	Idle Speed	Fuel Capacity	Oil Capacity	Standard Shutdowns
Diesel	Kubota D902T, 3-year warranty	24.8 hp at 2,800 rpm	Three-cylinder, industrial liquid-cooled turbocharged diesel with 60-amp alternator and electronic governor. Engine block heater standard	2,800 rpm	1,800 rpm	Chassis integrated	4.0 qt. (3.8 L)	Low oil pressure, high coolant temperature

Performance Data

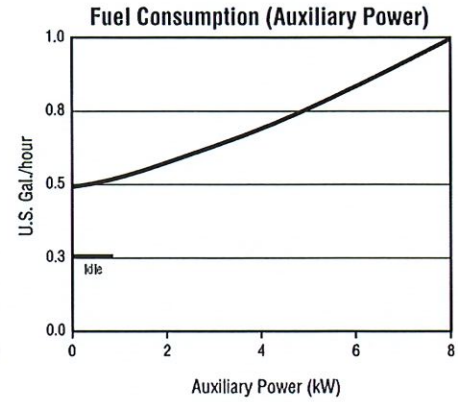
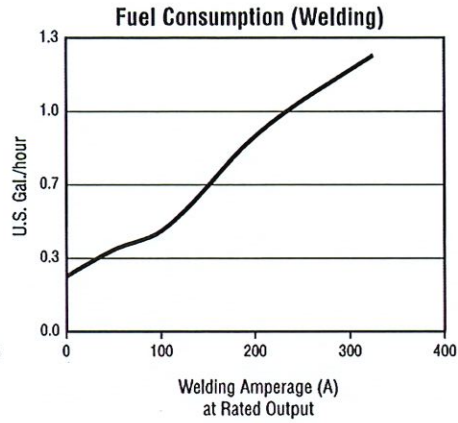
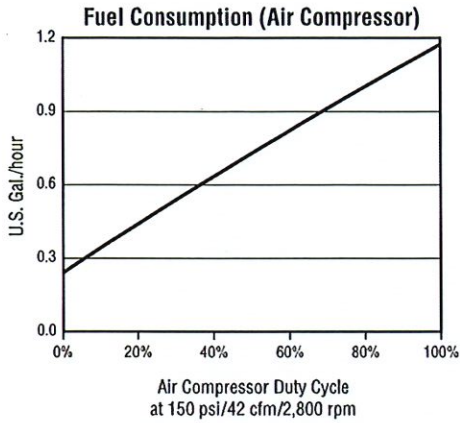

Mounting Specifications (See owner's manual for complete installation requirements.)

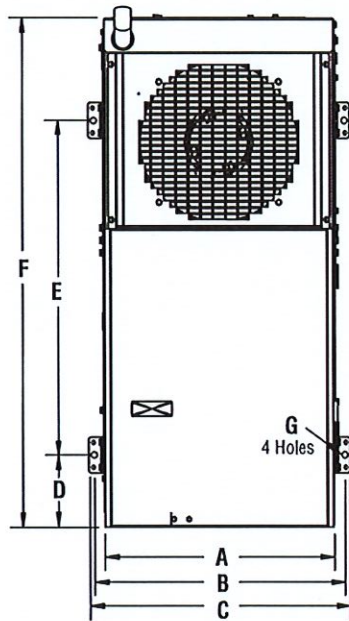

Note: Cooling fan and exhaust can be moved to accommodate under-deck installations.

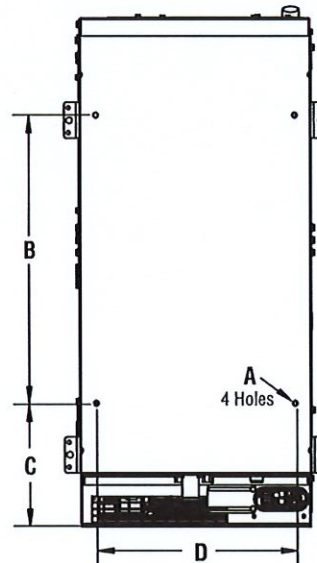

- External Mounting**
- A. 21 in. (533 mm)
 - B. 22.77 in. (578 mm)
 - C. 23.73 in. (603 mm)
 - D. 6.47 in. (164 mm)
 - E. 30.19 in. (767 mm)
 - F. 45.92 in. (1,166 mm)
 - G. 3/8 in. (9.5 mm) diameter
 - H. 22.73 in. (577 mm)

- Internal Mounting**
- A. 0.5 in. (12.7 mm) diameter
 - B. 26 in. (660 mm)
 - C. 11.12 in. (282 mm)
 - D. 18 in. (457 mm)

CabEn™ Climate Solutions (See literature ED/17.0.)

For work truck fleet managers who need to eliminate truck engine idle time, CabEn climate solutions are the only fully integrated cab heating and cooling systems that provide all-day relief from the outside environment while the truck engine is turned off.



CabEn Cool eCoolPark



CabEn Cool power converter

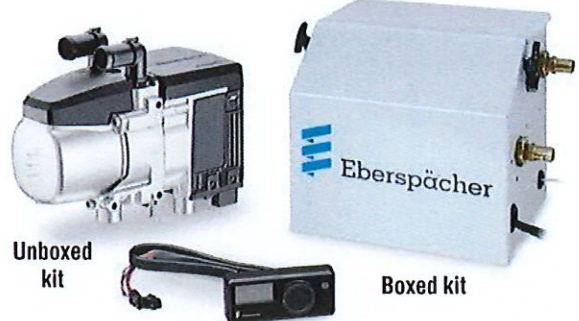

Unboxed kit

Boxed kit

CabEn Heat Hydronic HS3 and EasyStart Pro controller

The CabEn Cool utilizes eCoolPark™ from Bergstrom

- Innovative, eco-friendly, electric, no-idle HVAC system
- Integrates into the existing vehicle HVAC system to enable the user to shut off the engine, engage the vehicle blower and turn on the eCoolPark
- Maintains the interior temperature when the vehicle is turned off
- Coupled with the power converter, this system gives the user an all-day cab climate solution
- eCoolPark 1.5 Includes long-life brushless fan and compressor inside a heavy-duty enclosure and can be mounted on a horizontal or vertical surface
- Power converter converts 240 VAC to 24 VDC to provide all-day power from EnPak® to the eCoolPark 1.5

The CabEn Heat utilizes the Hydronic HS3™ from Eberspächer

- Double benefit: pre-heating the vehicle's passenger compartment and the truck engine
- The heaters are integrated in the cooling system of the engine
- The thermal energy gained is then distributed through the vehicle's own heat exchanger as forced hot air and this heats the interior of the vehicle via existing air vents — the engine is warmed up with the residual heat in the cooling water
- EasyStart Pro controller provides direct communication with the Hydronic HS3 with available functions such as system navigation, timer and onboard diagnostics

CabEn™ Climate Solutions Features



Integration

The compact size of CabEn Climate Pak integrates into the existing vehicle HVAC system and also allows for multiple installation locations.



Saves fuel

CabEn Climate Pak helps increase fuel savings and reduce engine hours while maintaining operator comfort.



Anti-idle solution

CabEn Climate Pak can reduce idle time and CO₂ emissions up to 70 percent.



Quality

The quality and reliability you expect from three proven brands: Miller, Bergstrom and Eberspächer.

Genuine Miller® Accessories

Cold Weather Kits

Cold Weather Kit 301614
Includes diesel fuel heater and compressor oil heater.

Maintenance Kits



Air Compressor Service Kit 279123
Includes compressor oil filter, inlet air filter, oil/air separator and compressor oil.



Diesel Engine Filter Kit 284101
Includes oil filter, air filter, fuel filter and secondary fuel filter.

Accessory Kit Packages



Ready To Work Accessory Kit 951858
Includes auxiliary power remote panel, battery charge/jump cables, and 50 ft. (15.2 m) weld cables with electrode holder and work clamp.

Air Compressor Accessories



Air Dryer Kit 301488
Cools and removes moisture from the air supply.

Note: Not recommended for use below 32°F (0°C). Water condensate in the cooler or separator can freeze causing reduced or blocked airflow.

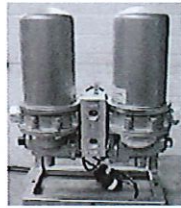

Desiccant Air Dryer System 195117
A regenerating inline air dryer system that eliminates moisture in the air stream to prevent air tool freeze-ups in cold climates. Internal thermostat and heating elements ensure good air quality in all climates. Side mounted system.

Generator Power Accessories



Auxiliary Power Remote Panel 301562
Includes two 120 V receptacles w/circuit breakers and one 120/240 V, 50 A receptacle. Cabling NOT included.



Full KVA Plug Kit 119172
120/240 V, 50 A plug (NEMA 14-50P) to fit full KVA receptacle.

GFCI Receptacle 282067
15/20 A receptacle with mounting tabs.



Female Receptacle 

Full KVA Adapter Cord 300517
NEMA 14-50P to NEMA 6-50R. Adapts engine drive 120/240 V plug to common Millermatic® and Spectrum® 240 V plug.

Battery Charge/Crank Assist Accessories



Battery Charge/Jump Cables with Plug 300422 25 ft. (7.6 m)

Hydraulic Pump Accessories

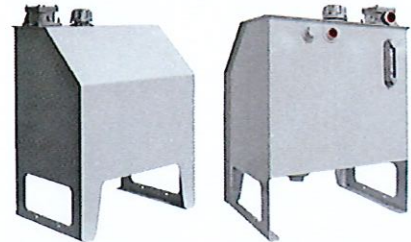

Hydraulic Tank Reservoir Kit 301612
20 gal. (76 L)

Closed Center Conversion Kit 301599
Load sense valve for closed center or load sense application.

Crane/Communication Adapters
300772 Auto Crane, Nexstar, wireless remote
301748 IMT Series IV Harness
300908 Stellar CDT
300832 Six Wire Crane (used for all other crane / non-crane applications)

Genuine Miller® Accessories

Weld Accessories

2/0 Weld Cable Sets 301566
350 amps, 100 percent duty cycle. 50-foot (15.2 m) cables with Tweco®-style male connectors and either an electrode holder or work clamp.



2/0 Weld Cables
195457 Cable with electrode holder
195458 Cable with work clamp
400 amps, 100 percent duty cycle. 10-foot (3 m) cable with Tweco®-style male connector and either an electrode holder or work clamp. Each includes a stud/Tweco® adapter.



2/0 Weld Cable Extension 195456
50-foot (15 m) cable extends weld cables 195457 and 195458. Two needed for a complete set.



No. 2 Weld Cable Sets 195196
200 amps, 100 percent duty cycle. 15-foot (4.6 m) cables with either an electrode holder or work clamp.



Tweco®-Style Connector 191981
Male Tweco-style plug.



ArcReach® SuitCase® 8
951726001 With Bernard® BTB Gun 300 A
951727 With Bernard® S-Gun™
951728 With Bernard® Dura-Flux™ gun
ArcReach® SuitCase® 12
951729001 With Bernard® BTB Gun 300 A
951730 With Bernard® S-Gun™
951731 With Bernard® Dura-Flux™ gun
Portable feeder designed to run off of arc voltage. See literature M/6.55.



Spoolmatic® 30A Spool Gun 130831
Rated at 200 amps, 100 percent duty cycle with 30-foot (9 m) cable. Also see MIG Aluminum Accessory Kit (951881) in Accessory Kit Packages section.



Spoolmate™ 200 Spool Gun 300497
Rated at 160 amps, 60 percent duty cycle with 20-foot (6 m) cable.

Extension Hose and Cable Kit 132228
25 ft. (7.6 m). For Spoolmatic 30A and Spoolmate 200 spool guns.

Flow Gauge Regulator 31-50-580
0–50 scfh, argon/CO₂

Plug-In Welders



Multimatic® 215 with TIG Contractor Kit 951674
Portable, all-in-one multiprocess welder features excellent arc characteristics. Connects to 120- or 240-volt power. See literature DC/12.59.

Plasma Cutters



Spectrum® 375 X-TREME™ 907529
Comes complete with protective X-CASE™ (not shown). See literature PC/9.2.



Spectrum® 625 X-TREME™ 907579
Comes complete with protective X-CASE™ (not shown). See literature PC/9.6.

EnPak® A60 Model and Accessories Selection

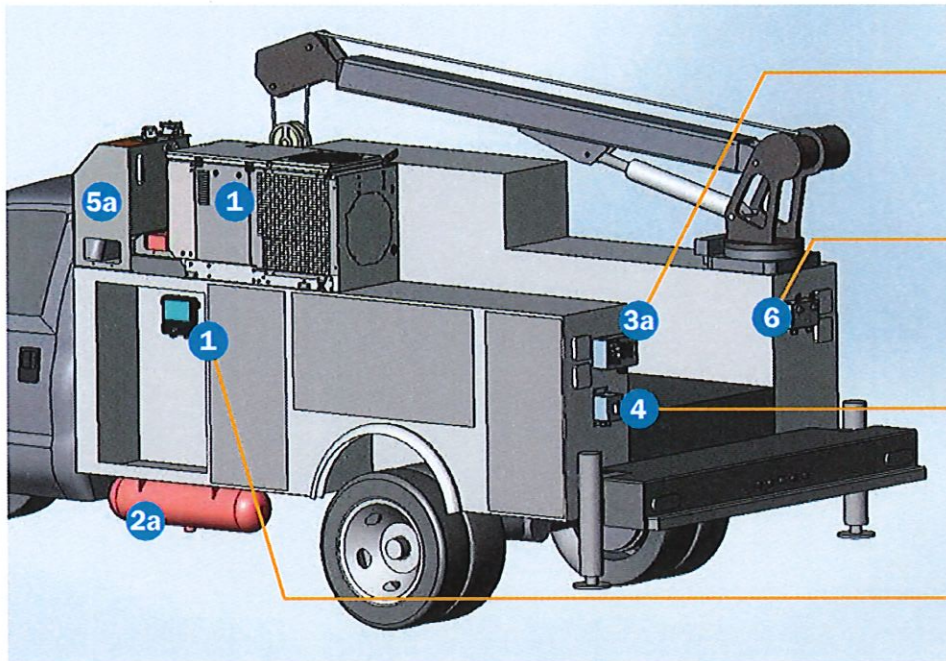

Auxiliary power remote panel
Optional on all models. Cabling is provided by integrator.



Weld output panel
Included on A60GBW and A60GBHW models only. Cabling is provided by integrator.



Battery charge/crank assist panel
Included on all models. Cabling is provided by integrator.



User interface panel
Included on all models. Includes 30 feet (9 m) of cabling.

1 EnPak A60 Models and Kits

- a** CHOOSE an A60 model (see models and features at right)
Included on all models are user interface panel with 30 ft. (9 m) of cabling, battery charge/crank assist panel, and engine block heater
Optional on all models is a cold weather package which adds factory-installed diesel fuel heater and compressor oil heater
- b** Cold weather and maintenance kits (see page 8 for options)
- c** Ready to work accessory kit package (see page 8)

	Features					
	Air Compressor	Generator Power	Battery Charge/Crank Assist	Hydraulic Pump	Weld	Cold Weather Package
1 EnPak A60 Model	2	3	4	5	6	
A60GB	•	•	•			
A60GB Cold Weather Package	•	•	•			•
A60GBH	•	•	•	•		
A60GBH Cold Weather Package	•	•	•	•		•
A60GBW	•	•	•		•	
A60GBW Cold Weather Package	•	•	•		•	•
A60GBHW	•	•	•	•	•	
A60GBHW Cold Weather Package	•	•	•	•	•	•

EnPak A60 Feature Accessories (sold separately)

2 Air Compressor

- a** REQUIRES 10-gallon minimum (20-gallon recommended) air reservoir for installation — NOT provided by Miller
- b** Air dryer kits (see page 8 for options)

3 Generator Power

- a** Auxiliary power remote panel
- b** Adapter cords and plugs (see page 8 for options)

4 Battery Charge/Crank Assist

- a** Battery charge / jump assist cables

5 Hydraulic Pump (A60GBH and A60GBHW models only)

- a** Hydraulic tank reservoir kit
- b** Hydraulic closed center conversion kit
- c** Crane / communication adapters (see page 8 for options)

6 Weld (A60GBW and A60GBHW models only)

- a** Weld cables and connectors (see page 9 for options)
- b** Wire feeders (see page 9 for options)
- c** Spool guns / spool gun accessories (see page 9 for options)

Ordering Information

Equipment and Options	Stock No.	Description	Qty.	Price
1a EnPak® A60GB	907813	Air compressor, generator power, battery charge/crank assist and chassis power		
EnPak® A60GB Cold Weather Package	907813001	Same as 907813 above, plus factory-installed diesel fuel heater and compressor oil heater		
EnPak® A60GBH	907814	Air compressor, generator power, battery charge/crank assist, chassis power and hydraulic pump		
EnPak® A60GBH Cold Weather Package	907814001	Same as 907814 above, plus factory-installed diesel fuel heater and compressor oil heater		
EnPak® A60GBW	907856	Air compressor, generator power, battery charge/crank assist, chassis power and weld		
EnPak® A60GBW Cold Weather Package	907856001	Same as 907856 above, plus factory-installed diesel fuel heater and compressor oil heater		
EnPak® A60GBHW	907815	Air compressor, generator power, battery charge/crank assist, chassis power, hydraulic pump and weld		
EnPak® A60GBHW Cold Weather Package	907815001	Same as 907815 above, plus factory-installed diesel fuel heater and compressor oil heater		
Cold Weather and Maintenance Kits				
1b Cold Weather Kit	301614	Includes diesel fuel heater and compressor oil heater		
Air Compressor Service Kit	279123	Includes compressor oil filter, inlet air filter, oil/air separator and compressor oil		
Diesel Engine Filter Kit	284101	Includes oil filter, air filter and secondary fuel filter		
Accessory Kit Package				
1c Ready To Work Accessory Kit	951858	Includes auxiliary power remote panel (cabling not included), battery charge/jump cables, and 50 ft. (15.2 m) weld cables with electrode holder and work clamp		
Air Compressor Accessories				
2a	REQUIRES 10-gallon (20-gallon recommended) minimum air reservoir for installation — NOT provided by Miller			
2b Air Dryer Kit	301488	Cools and removes moisture from the air supply		
Desiccant Air Dryer System	195117	Regenerating inline air dryer system that eliminates moisture in the air stream		
Generator Power Accessories				
3a Auxiliary Power Remote Panel	301562	Includes and two 120 V receptacles w/circuit breakers and one 120/240 V, 50 A receptacle (no EnVerter receptacles) — cabling NOT included		
3b Full KVA Plug Kit	119172	120/240 V, 50 A plug (NEMA 14-50P) to fit full KVA receptacle		
GFCI Receptacle	282067	15/20 A receptacle with mounting tabs		
Full KVA Adapter Cord	300517	NEMA 14-50P to NEMA 6-50R. Adapts engine drive 120/240 V plug to common Millermatic® and Spectrum® 240 V plug		
Battery Charge/Crank Assist Accessories				
4a Battery Charge/Jump Cables with Plug	300422	25 ft. (7.6 m)		
Hydraulic Pump Accessories (A60GBH and A60GBHW models only)				
5a Hydraulic Tank Reservoir Kit	301612	20 gal. (76 L)		
5b Hydraulic Closed Center Conversion Kit	301599	Load sense valve for closed center or load sense application		
5c Crane/Communication Adapters		See page 8		
Weld Accessories (A60GBW and A60GBHW models only)				
6a Weld Cables and Connectors		See page 9		
6b Wire Feeders		See page 9		
6c Spool Guns/Spool Gun Accessories		See page 9		
Plug-In Welders		See page 9 (requires auxiliary power remote panel on page 8)		
Plasma Cutters		See page 9 (requires auxiliary power remote panel on page 8)		

Date:

Total Quoted Price:

Distributed by:

